



# MiniRAE 3000 ppbRAE 3000



## Basic Operation Pocket Reference

PN: 059-4030-000-D  
Rev. B August 2010

# MiniRAE 3000/ppbRAE 3000 Pocket Reference

## Read Before Operating

This Pocket Reference is intended as a quick guide to basic use and calibration of your instrument. It does not cover advanced features. Information on advanced features and other operation modes is included in the User's Guide.

The User's Guide must be carefully read by all individuals who have or will have the responsibility of using, maintaining, or servicing this product. The product will perform as designed only if it is used, maintained, and serviced in accordance with the manufacturer's instructions. The user should understand how to set the correct parameters and interpret the obtained results.

### **CAUTION!**

To reduce the risk of electric shock, turn the power off before removing the instrument cover. Disconnect the battery before removing sensor module for service. Never operate the instrument when the cover is removed. Remove instrument cover and sensor module only in an area known to be non-hazardous.

## MiniRAE 3000/ppbRAE 3000 Pocket Reference

### WARNINGS

**STATIC HAZARD:** Clean only with damp cloth.

For safety reasons, this equipment must be operated and serviced by qualified personnel only. Read and understand the User's Guide completely before operating or servicing.

Use only RAE Systems battery packs, part numbers 059-3051-000, 059-3052-000, and 059-3054-000. This instrument has not been tested in an explosive gas/air atmosphere having an oxygen concentration greater than 21%. Substitution of components may impair intrinsic safety. Recharge batteries only in non-hazardous locations.

Do not mix old and new batteries or batteries from different manufacturers.

The calibration of all newly purchased RAE Systems instruments should be tested by exposing the sensor(s) to known concentration calibration gas before the instrument is put into service.

## MiniRAE 3000/ppbRAE 3000 Pocket Reference

For maximum safety, the accuracy of the instrument should be checked by exposing it to a known concentration calibration gas before each day's use.

Do not use USB/PC communication in hazardous locations.

**Intrinsic Safety:** US and Canada: Class I, Division 1,  
Groups A,B, C, D  
Europe: ATEX (0575 Ex II 2G Ex ia  
IIC/IIB T4 Gb)  
KEMA 07 ATEX 0127  
Complies with EN60079-0:2009,  
EN60079-11:2007  
IECEX CSA 10.0005 Ex ia IIC/IIB T4 Gb  
Complies with IEC 60079-0:2007,  
IEC 60079-11:2006  
(IIC: 059-3051-000 Li-ion bat pack or  
059-3054-000 NiMH bat pack;  
IIB: 059-3052-000 alkaline bat pack)

## MiniRAE 3000/ppbRAE 3000 Pocket Reference

### Special Notes



When the instrument is taken out of the transport case and turned on for the first time, there may be some residual organic or inorganic vapor trapped inside the detector chamber. The initial PID sensor reading may indicate a few ppm. Enter an area known to be free of any organic vapor and turn on the instrument. After running for several minutes, the residual vapor in the detector chamber will be cleared and the reading should return to zero.



The battery of the instrument discharges slowly even if it is turned off. If the instrument has not been charged for 5 to 7 days, the battery voltage will be low. Therefore, it is a good practice to always charge the instrument before using it. It is also recommended to fully charge the instrument for *at least 10 hours* before first use. Refer to the User Guide's section on battery charging for more information on battery charging and replacement.

# MiniRAE 3000/ppbRAE 3000 Pocket Reference

## Contents

Charging The Battery .....	6
Charging A Spare Rechargeable Battery .....	8
Pump Status & Calibration Status .....	10
User Interface.....	12
Display.....	15
Operating The Instrument.....	16
Turning The Instrument On.....	17
Turning The Instrument Off.....	18
Operating The Built-In Flashlight .....	18
Basic User Mode/Hygiene Mode .....	19
Entering Calibration.....	21
Standard Two-Point Calibration (Zero & Span).....	23
Zero (Fresh Air) Calibration.....	25
Span Calibration.....	28
Exiting Two-Point Calibration .....	32
Alarm Signal Summary .....	33
Preset Alarm Limits & Calibration.....	35
Sampling Pump.....	36
Ordering Replacement Parts .....	37
Special Servicing Note .....	38
Troubleshooting.....	38
Technical Support.....	Back cover

# MiniRAE 3000/ppbRAE 3000 Pocket Reference

## Charging The Battery

Always fully charge the battery before using the instrument. The instrument's Li-ion battery is charged by placing the instrument in its cradle. Contacts on the bottom of the instrument meet the cradle's contacts, transferring power without other connections.

**Note:** Before setting the instrument into its charging cradle, visually inspect the contacts to make sure they are clean. If they are not, wipe them with a soft cloth. Do not use solvents or cleaners.

Follow this procedure to charge the instrument:

1. Plug the AC/DC adapter's barrel connector into the instrument's cradle.



## MiniRAE 3000/ppbRAE 3000 Pocket Reference

2. Plug the AC/DC adapter into the wall outlet.
3. Place the instrument into the cradle, press down, and lean it back. It locks in place and the LED in the cradle glow

The instrument begins charging automatically. The “Primary” LED in the cradle blinks green to indicate charging. During charging, the diagonal lines in the battery icon on the instrument’s display are animated and you see the message “Charging...”

When the instrument’s battery is fully charged, the battery icon is no longer animated and shows a full battery. The message “Fully charged!” is shown. The cradle’s LED glows continuously green.



**Note:** If you see the “Battery Charging Error” icon (a battery outline with an exclamation mark inside), check that the instrument or rechargeable battery has been set into the





## **MiniRAE 3000/ppbRAE 3000 Pocket Reference**

cradle properly. If you still receive the message, check the Troubleshooting section of this guide.

### **Charging A Spare Rechargeable Battery**

A rechargeable Li-ion battery can be charged when it is not inside the monitor. The charging cradle is designed to accommodate both types of charging. Contacts on the bottom of the battery meet the contacts on the cradle, transferring power without other connections, and a spring-loaded capture holds the battery in place during charging.

1. Plug the AC/DC adapter into the monitor's cradle.
2. Place the battery into the cradle, with the gold-plated contacts on top of the six matching charging pins.
3. Plug the AC/DC adapter into the wall outlet.

The battery begins charging automatically. During charging, the Secondary LED in the cradle blinks green. When charging is complete, it glows steady green.

## **MiniRAE 3000/ppbRAE 3000 Pocket Reference**

Release the battery from the cradle by pulling it back toward the rear of the cradle and tilting it out of its slot.

**Note:** If you need to replace the Li-ion battery pack, replacements are available from RAE Systems. The part number is 059-3051-000.

**Note:** An Alkaline Battery Adapter (part number 059-3052-000), which uses four AA alkaline batteries (Duracell MN1500), may be substituted for the Li-Ion battery.

### **WARNING!**

To reduce the risk of ignition of hazardous atmospheres, recharge and replace batteries only in areas known to be non-hazardous. Remove and replace batteries only in areas known to be non-hazardous.

## MiniRAE 3000/ppbRAE 3000 Pocket Reference

### Low Voltage Warning

When the battery's charge falls below a preset voltage, the instrument warns you by beeping once and flashing once every minute, and the “empty battery” icon blinks on and off once per second. Turn off the instrument within 10 minutes and either recharge the battery by placing the instrument in its cradle, or replace the battery with a fresh one with a full charge.



### Pump Status

During operation, make sure the probe inlet and the gas outlet are free of obstructions. Obstructions can cause premature wear on the pump, false readings, or pump stalling. During normal operation, the pump icon alternately shows inflow and outflow as shown here:

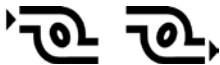

During duty cycling (PID lamp cleaning), the display shows these icons in alternation:



## MiniRAE 3000/ppbRAE 3000 Pocket Reference

If there is a pump failure or obstruction that disrupts the pump, you will see this icon blinking on and off:



If you see this blinking icon, consult the Troubleshooting section in the User's Guide.

## Calibration Status

The instrument displays this icon if it requires calibration:



Calibration is required (and indicated by this icon) if:

- The lamp type has been changed (for example, from 10.6 eV to 9.8 eV).
- The sensor has been replaced.
- It has been 30 days or more since the instrument was last calibrated.
- If you have changed the calibration gas type without recalibrating the instrument.

# **MiniRAE 3000/ppbRAE 3000 Pocket Reference**

## **User Interface**

The instrument's user interface consists of the display, LEDs, an alarm transducer, and four keys. The keys are:

Y/+

MODE

N/-

Flashlight on/off

The LCD display provides visual feedback that includes time, battery condition, and other functions.

In addition to their labeled functions, the keys labeled Y/+, MODE, and N/- act as “soft keys” that control different parameters and make different selections within the instrument's menus. From menu to menu, each key controls a different parameter or makes a different selection.

# MiniRAE 3000/ppbRAE 3000 Pocket Reference

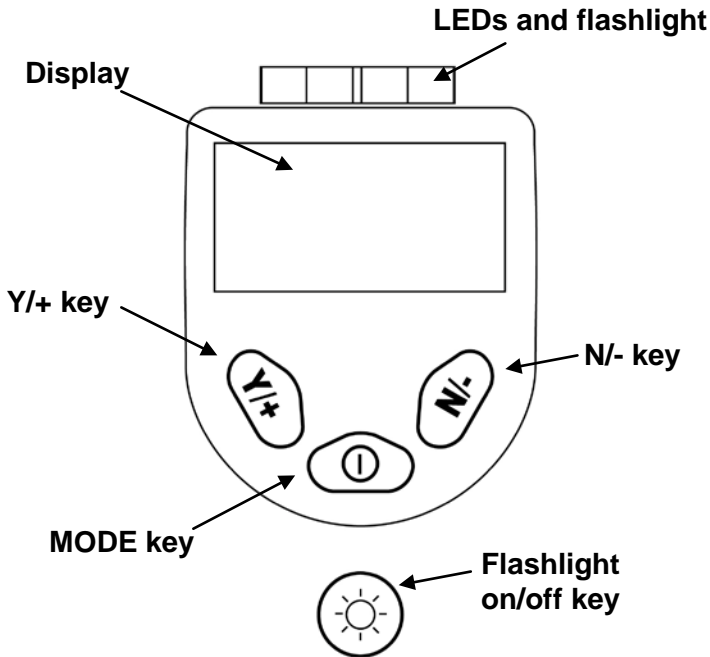

## MiniRAE 3000/ppbRAE 3000 Pocket Reference

Three panes along the bottom of the display are “mapped” to the keys. These change as menus change, but at all times the left pane corresponds to the [Y/+]  
key, the center pane corresponds to the [MODE] key, and the right pane corresponds to the [N/-] key. Here are three examples of different menus with the relationships of the keys clearly shown:

### RELATIONSHIP OF BUTTONS TO CONTROL FUNCTIONS

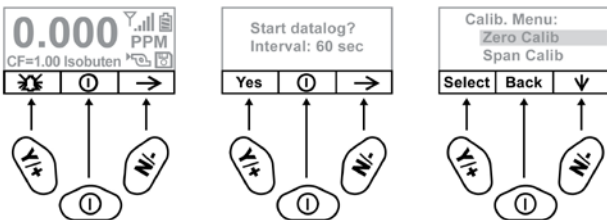

# MiniRAE 3000/ppbRAE 3000 Pocket Reference

## Display

The display shows the following information:

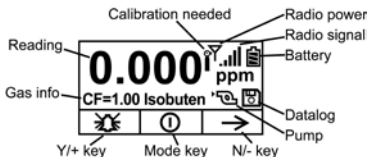

### Graph

Graphic representation of concentration plotted over time

### Gas info\*

Tells the Correction Factor and type of calibration gas

### Reading

Concentration of gas as measured

### Calibration needed

Indicates that calibration should be performed

### Radio power

Indicates whether radio connection is on or off

### Radio signal

Indicates signal strength in 5-bar bargraph

### Battery

Indicates battery level in 3 bars

### Pump

Indicates that pump is working

### Datalog

Indicates whether datalog is on or off

### Y/+

Y/+ key's function for this screen

### MODE

MODE key's function for this screen

### N/-

N/- key's function for this screen



## **MiniRAE 3000/ppbRAE 3000 Pocket Reference**

### **Operating The Instrument**

The instrument is designed as a broadband VOC gas monitor and datalogger for work in hazardous environments. It gives real-time measurements and activates alarm signals whenever the exposure exceeds preset limits. Prior to factory shipment, the instrument is preset with default alarm limits and the sensor is pre-calibrated with standard calibration gas. However, you should test the instrument and verify the calibration before the first use. After the instrument is fully charged and calibrated, it is ready for immediate operation.

## MiniRAE 3000/ppbRAE 3000 Pocket Reference

### Turning The Instrument On

1. With the instrument turned off, press and hold [MODE].
2. When the display turns on, release the [MODE] key.



The instrument is now operating and performs self tests. If any tests (including sensor and memory tests fail), refer to the Troubleshooting section of the User's Guide.

**Note:** In Basic User/Hygiene Mode (the default setting), the instrument stops after self-testing, and asks whether to perform a zero air (fresh air) calibration. You can start this calibration, quit, or abort the calibration while the instrument is undergoing calibration. When the zero calibration is done, you see screen telling you that the zero calibration is complete, along with its value. After calibration (or after you abort the calibration), the instrument then shows a numerical reading screen with icons. This indicates that the instrument is fully functional and ready to use.

## **MiniRAE 3000/ppbRAE 3000 Pocket Reference**

### **Turning The Instrument Off**

1. Press and hold the Mode key for 3 seconds. A 5-second countdown to shutoff begins.
2. Once the countdown stops, the instrument is off. Release the Mode key.
3. When you see “Unit off...” release your finger from the [MODE] key. The instrument is now off.

**Note:** You must hold your finger on the key for the entire shutoff process. If you remove your finger from the key during the countdown, the shutoff operation is canceled and the instrument continues normal operation.

### **Operating The Built-In Flashlight**

The instrument has a built-in flashlight that helps you point the probe in dark places. Press the flashlight key to turn it on. Press it again to turn it off.

**Note:** Using the flashlight for extended periods shortens the battery’s operating time before it needs recharging.

## MiniRAE 3000/ppbRAE 3000 Pocket Reference

### Basic User Mode/Hygiene Mode (Default Settings)

The instrument is programmed to operate in Basic User Mode/Hygiene Mode as its default. This gives you the most commonly needed features while requiring the fewest parameter adjustments.

Pressing [N/-] steps you from one screen to the next, and eventually return to the main display. If you do not press a key within 60 seconds after entering a display, the instrument reverts to its main display.

**Note:** While viewing any of these screens, you can shut off your instrument by pressing [MODE].

**Note:** Whenever you see the alarm icon in the lower left pane, you can press [Y/+] to test the alarms.

# MiniRAE 3000/ppbRAE 3000 Pocket Reference

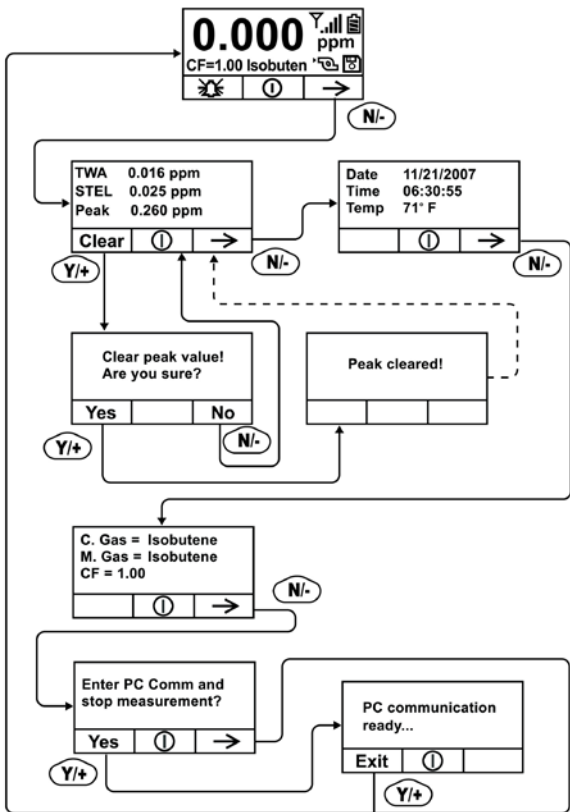

## MiniRAE 3000/ppbRAE 3000 Pocket Reference

### Entering Calibration

1. Press and hold [MODE] and [N/-] until you see the Password screen.

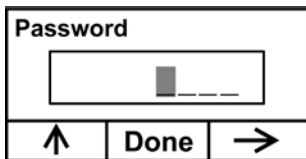

2. In Basic User Mode, you do not need a password to perform calibrations. Instead of inputting a password, enter calibration by pressing [MODE].

**Note:** If you inadvertently press [Y/+] and change any of the numbers, simply press [MODE] and you will be directed to the calibration menu.

## MiniRAE 3000/ppbRAE 3000 Pocket Reference

The Calibration screen is now visible with Zero Calibration highlighted.

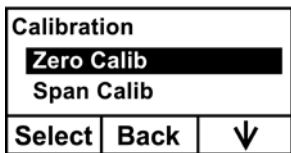

These are your options:

- Press [Y/+] to select the highlighted calibration (Zero Calib or Span Calib).
- Press [MODE] to exit calibration and return to the main display and resume measurement.
- Press [N/-] to toggle the highlighted calibration type.

## **MiniRAE 3000/ppbRAE 3000 Pocket Reference**

### **Standard Two-Point Calibration (Zero & Span)**

The following diagram shows the instrument's calibrations in Basic/Hygiene mode.

**Note:** In the diagram, a dashed line indicates automatic change to another screen.





## **MiniRAE 3000/ppbRAE 3000 Pocket Reference**

### **Zero (Fresh Air) Calibration**

This procedure determines the zero point of the sensor calibration curve. To perform a fresh air calibration, use the calibration adapter to connect the instrument to a “fresh” air source such as from a cylinder or Tedlar bag (optional accessory). The “fresh” air is clean, dry air without organic impurities and an oxygen value of 20.9%. If such an air cylinder is not available, any clean ambient air without detectable contaminants or a charcoal filter can be used.

At the Zero Calibration menu, you can proceed to perform a Zero calibration or bypass Zero calibration and perform a Span calibration. You may also go back to the initial Calibration menu if you want to exit calibration.

- Press [Y/+] to start calibration.
- Press [MODE] to quit and return to the main calibration display.

## MiniRAE 3000/ppbRAE 3000 Pocket Reference

If you have pressed [Y/+] to enter Zero calibration, then you will see this message:

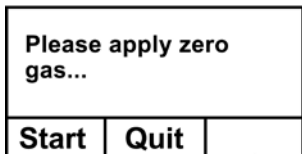

1. Turn on your Zero calibration gas.
2. Press [Y/+] to start calibration.

**Note:** At this point, you may press [MODE] if you decide that you do not want to initiate calibration. This will take you directly to the Calibration menu, highlighted for Span calibration.

3. Zero calibration starts and displays this message:

Zeroing...

## **MiniRAE 3000/ppbRAE 3000 Pocket Reference**

During the zeroing process, the instrument performs the Zero calibration automatically and does not require any actions on your part.

**Note:** To abort the zeroing process at any time and proceed to Span calibration, press [N/-] at any time while zeroing is being performed. You will see a confirmation message that says “Zero is aborted!” and then the Span calibration menu appears.

When Zero calibration is complete, you see this message:

Zeroing is done!  
Reading = 0.000 ppm

The instrument will then show the Calibration menu on its display, with Span Calib highlighted.

## **MiniRAE 3000/ppbRAE 3000 Pocket Reference**

### **Span Calibration**

This procedure determines the second point of the sensor calibration curve for the sensor. A cylinder of standard reference gas (span gas) fitted with a 500 cc/min. flow-limiting regulator or a flow-matching regulator is the simplest way to perform this procedure. Choose the 500 cc/min. regulator only if the flow rate matches or slightly exceeds the flow rate of the instrument pump. Alternatively, the span gas can first be filled into a Tedlar bag or delivered through a demand-flow regulator. Connect the calibration adapter to the inlet port of the instrument, and connect the tubing to the regulator or Tedlar bag.

Another alternative is to use a regulator with  $>500$  cc/min flow but allow the excess flow to escape through a T or an open tube. In the latter method, the span gas flows out through an open tube slightly wider than the probe, and the probe is inserted into the calibration tube. At the Span Calibration menu, you perform a Span calibration. You may also go back to the Zero calibration menu or to the initial Calibration menu if you want to exit calibration.

## MiniRAE 3000/ppbRAE 3000 Pocket Reference

- Press [Y/+] to enter Span calibration.
- Press [N/-] to skip Span calibration and return to Zero calibration.
- Press [MODE] to exit Span calibration and return to the top calibration menu.

If you have pressed [Y/+] to enter Span calibration, then you will see the name of your Span gas (the default is isobutylene) and the span value in parts per million (ppm). You will also see this message that prompts you:

<b>C. Gas = Isobutene</b>		
<b>Span = 10 ppm</b>		
<b>Please apply gas 1...</b>		
<b>Start</b>	<b>Quit</b>	

1. Turn on your span calibration gas.
2. Press [Y/+] to initiate calibration.

**Note:** You may press [MODE] if you decide

## MiniRAE 3000/ppbRAE 3000 Pocket Reference

that you do not want to initiate calibration. This will abort the span calibration and take you directly to the Calibration menu for Zero calibration.

3. Span calibration starts and displays this message:

Calibrating...

During the Span calibration process, there is a 30-second countdown and the instrument performs the Span calibration automatically. It requires no actions on your part.

**Note:** If you want to abort the Span calibration process, press [N/-] at any time during the process. You will see a confirmation message that says “Span is aborted!” and then the Zero calibration menu appears. You can then proceed to perform a Zero calibration, perform a Span calibration, or exit to the topmost Calibration menu.

## **MiniRAE 3000/ppbRAE 3000 Pocket Reference**

When Span calibration is complete, you see this message:

Span 1 is done!  
Reading = 100.0 ppm

The instrument then exits Span calibration and shows the Zero calibration menu on its display.

**Note:** The reading should be very close to the span gas value.



## **MiniRAE 3000/ppbRAE 3000 Pocket Reference**

### **Exiting Two-Point Calibration**

When you are done performing calibrations, press [MODE], which corresponds with “Back” on the display. You will see the following message:

Updating settings...

The instrument updates its settings and then returns to the main display. It begins or resumes monitoring.

## MiniRAE 3000/ppbRAE 3000 Pocket Reference

### Alarm Signal Summary

If the measured gas concentration exceeds any of the preset limits, the buzzer and red flashing LED are activated immediately to warn you of the alarm condition. The instrument also alarms if one of the following conditions occurs: battery voltage falls below a preset voltage level, failure of the UV lamp, or pump stall.

<b>Mess- age</b>	<b>Condition</b>	<b>Alarm Signal</b>
HIGH	Gas exceeds “High Alarm” limit	3 beeps/flashes per second*
OVR	Gas exceeds measurement range	3 beeps/flashes per second
MAX	Gas exceeds electronics’ maximum range	3 beeps/flashes per second
LOW	Gas exceeds “Low Alarm” limit	2 beeps/flashes per second*
TWA	Gas exceeds “TWA” limit	1 Beep/flash per second*

## MiniRAE 3000/ppbRAE 3000 Pocket Reference

STEL	Gas exceeds “STEL” limit	1 Beep/flash per second*
Pump icon flashes	Pump failure	3 beeps/flashes per second
Lamp	PID lamp failure	3 beeps/flashes per second plus “Lamp” message on display
Battery icon flashes	Low battery	1 flash per minute, 1 beep per minute plus battery icon flashes on display
CAL	Calibration failed, or needs calibration	1 beep/flash per second
NEG	Gas reading measures less than number stored in calibration	1 beep/flash per second

\* Hygiene mode only. In Search mode, the number of beeps per second (1 to 7) depends upon the concentration of the sampled gas.

## MiniRAE 3000/ppbRAE 3000 Pocket Reference

### Preset Alarm Limits & Calibration

The instrument is factory calibrated with standard calibration gas, and is programmed with default alarm limits.

<b>Cal Gas (Isobu- tylene)</b>	<b>Cal Span</b>	<b>unit</b>	<b>Low</b>	<b>High</b>	<b>TWA</b>	<b>STEL</b>
ppbRAE 3000	10	ppm	10	25	10	25
MiniRAE 3000	100	ppm	50	100	10	25

## **MiniRAE 3000/ppbRAE 3000 Pocket Reference**

### **Sampling Pump**

When approaching the end of the specified lifetime of the pump, it will consume higher amount of energy and reduce its sample draw capability significantly. When this occurs, it is necessary to replace or rebuild the pump. When checking the pump flow, make sure that the inlet connector is tight and the inlet tubing is in good condition. Connect a flow meter to the gas inlet probe. The flow rate should be above 450 cc/min when there is no air leakage.

If the pump is not working properly, refer the instrument to qualified service personnel for further testing and, if necessary, pump repair or replacement.

## **MiniRAE 3000/ppbRAE 3000 Pocket Reference**

### **Ordering Replacement Parts**

If you need replacement parts, contact your local RAE Systems distributor. A list is available online:

<http://www.raesystems.com>

In the U.S., you can order sensors, replacement batteries, and other accessories online at:

<http://istore.raesystems.com/>

## **MiniRAE 3000/ppbRAE 3000 Pocket Reference**

### **Special Servicing Note**

If the instrument needs to be serviced, contact either:

1. The RAE Systems distributor from whom the instrument was purchased; they will return the instrument on your behalf.
2. The RAE Systems Technical Service Department. Before returning the instrument for service or repair, obtain a Returned Material Authorization (RMA) number for proper tracking of your equipment. This number needs to be on all documentation and posted on the outside of the box in which the instrument is returned for service or upgrade. Packages without RMA Numbers will be refused at the factory.

### **Troubleshooting**

Refer to the User's Guide for troubleshooting details.



## **RAE Systems by Honeywell**

3775 N. First St.  
San Jose, CA 95134-1708 USA

**Web:** [www.raesystems.com](http://www.raesystems.com)

### **Technical Support**

To contact RAE Systems Technical Support Team:

Monday through Friday, 7:00AM to 5:00PM Pacific  
(US) Time

Phone (toll-free): +1 888-723-4800

Phone: +1 408-952-8461

Email: [tech@raesystems.com](mailto:tech@raesystems.com)

PN: 059-4030-000-D

Rev. B August 2010